

HOSE PUMP Model VPH65 SHOE TECHNOLOGY



Specifications

Flow per revolution:	3,833 l
Max. discharge pressure:	15 bar
Std. connections:	flanged DN65 (ANSI 2"½)
Internal hose diam.:	mm.65
Max liquid temp.:	80°C (176°F)
Achievable suction:	up to 0,9 bar
Suitable for:	continuous operation



VPH65 Performance

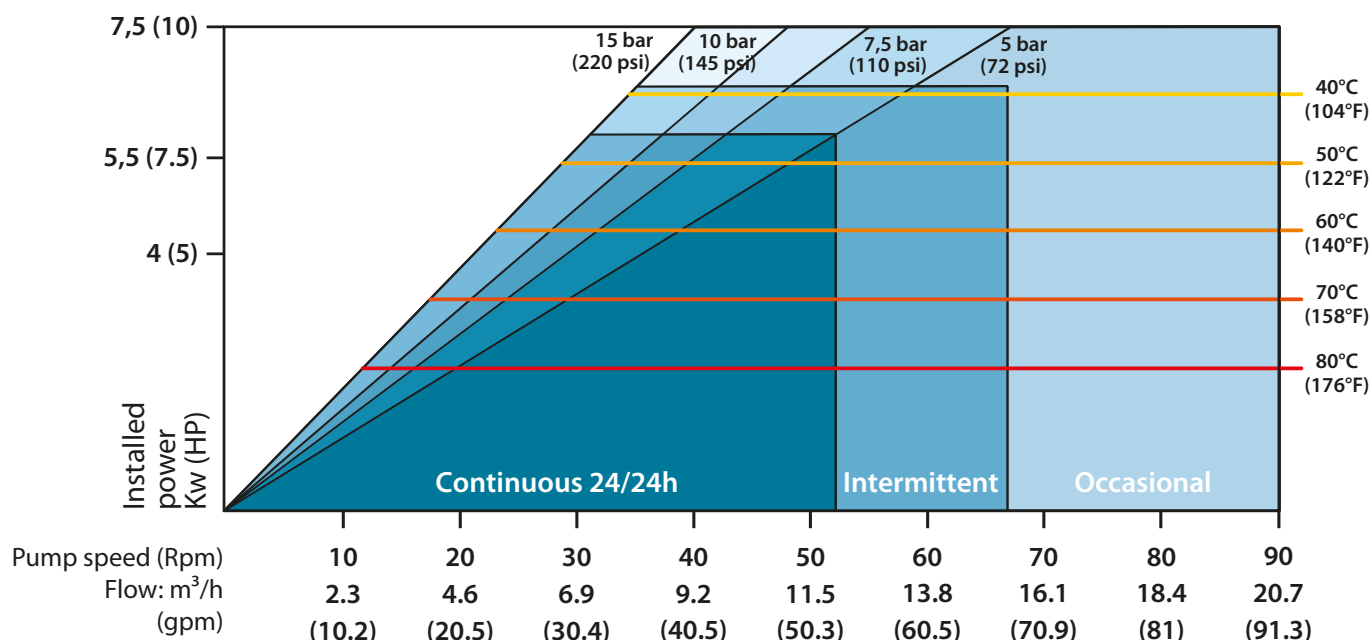





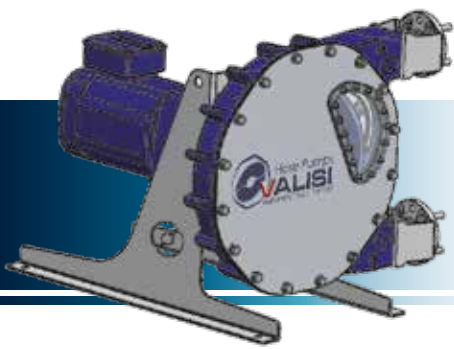

Valisi Hose pumps a brand of Asco Pompe

Via Silvio Pellico, 6/8 - 20089 Rozzano (MI) - ITALY
 Phone: +39 02 89257.1 - Fax: +39 02 89257.201
www.ascopompe.com - www.valisipumps.com
asco@ascopompe.com - info@valisipumps.com
hosepumps@valisipumps.com



Hose construction

-  NR (black hose, white stripe)
-  NBR - Nitrile (black hose, yellow stripe)
-  EPDM (black hose, red stripe)
-  Hypalon - CSM (black hose, blue stripe)
-  FKM - Viton® (black hose, purple stripe)
-  NR FDA - Natural rubber FDA (black hose with internal white layer, double white stripe)
-  NBR FDA - Nitrile FDA (black hose, white/yellow stripe)

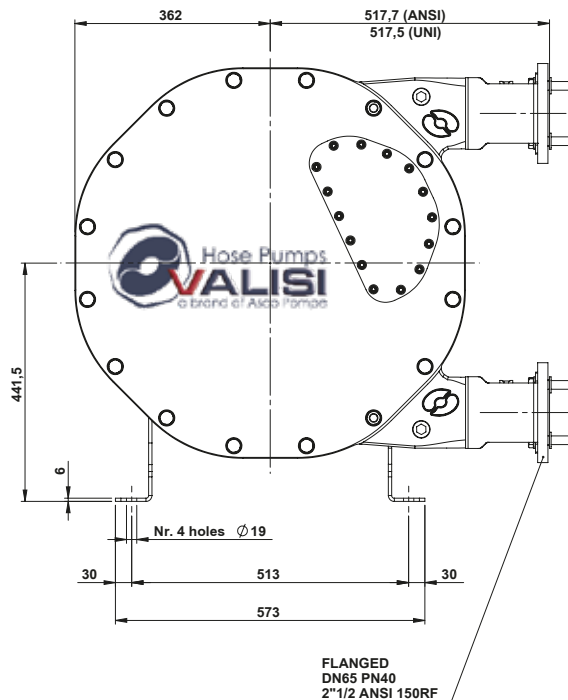
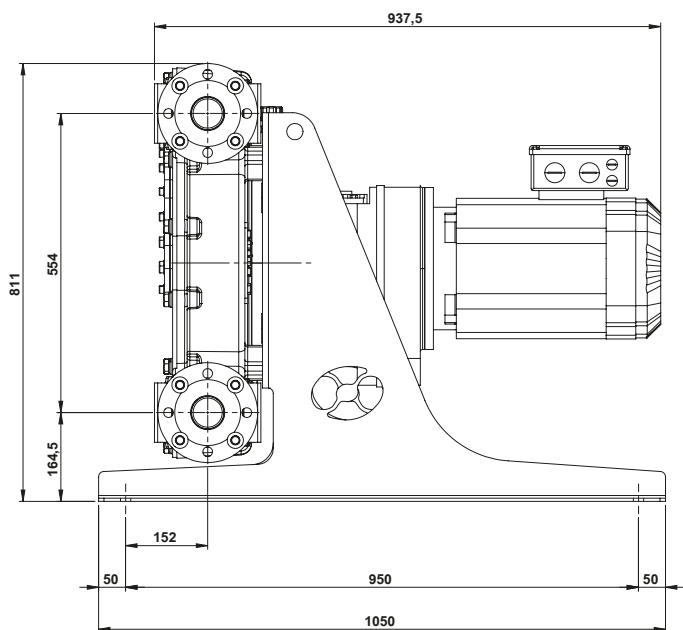

Weight

Bare pump:	195 kg
Complete unit:	335 Kg



Valisi Hose pumps a brand of Asco Pompe

Via Silvio Pellico, 6/8 - 20089 Rozzano (MI) - ITALY
 Phone: +39 02 89257.1 - Fax: +39 02 89257.201
 www.ascopompe.com - www.valisipumps.com
 asco@ascopompe.com - info@valisipumps.com
 hosepumps@valisipumps.com