

# HOSE PUMP Model VPH40 SHOE TECHNOLOGY

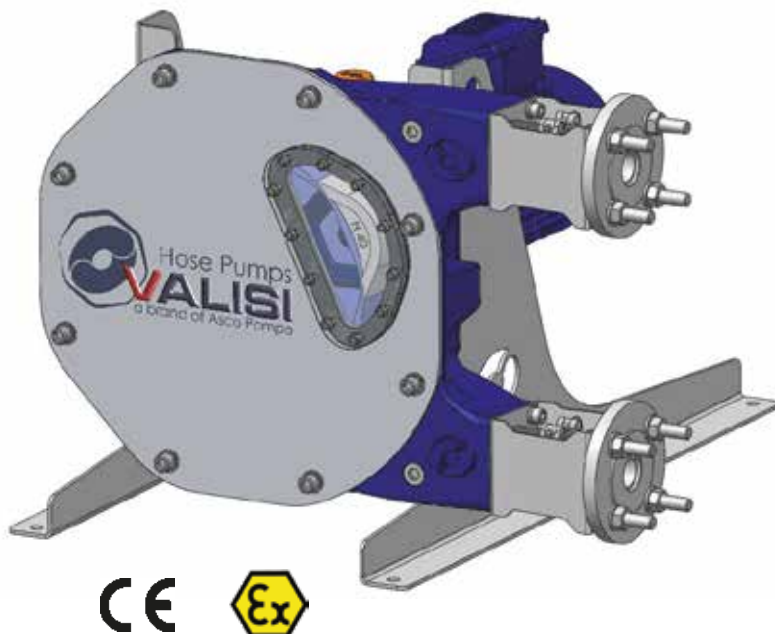

## Specifications

Flow per revolution:	0,975 l
Max. discharge pressure:	15 bar
Std. connections:	flanged DN40 (ANSI 1 1/2")
Internal hose diam.:	mm.40
Max liquid temp.:	80°C (176°F)
Achievable suction:	up to 0,9 bar
Suitable for:	continuous operation



## VPH40 Performance

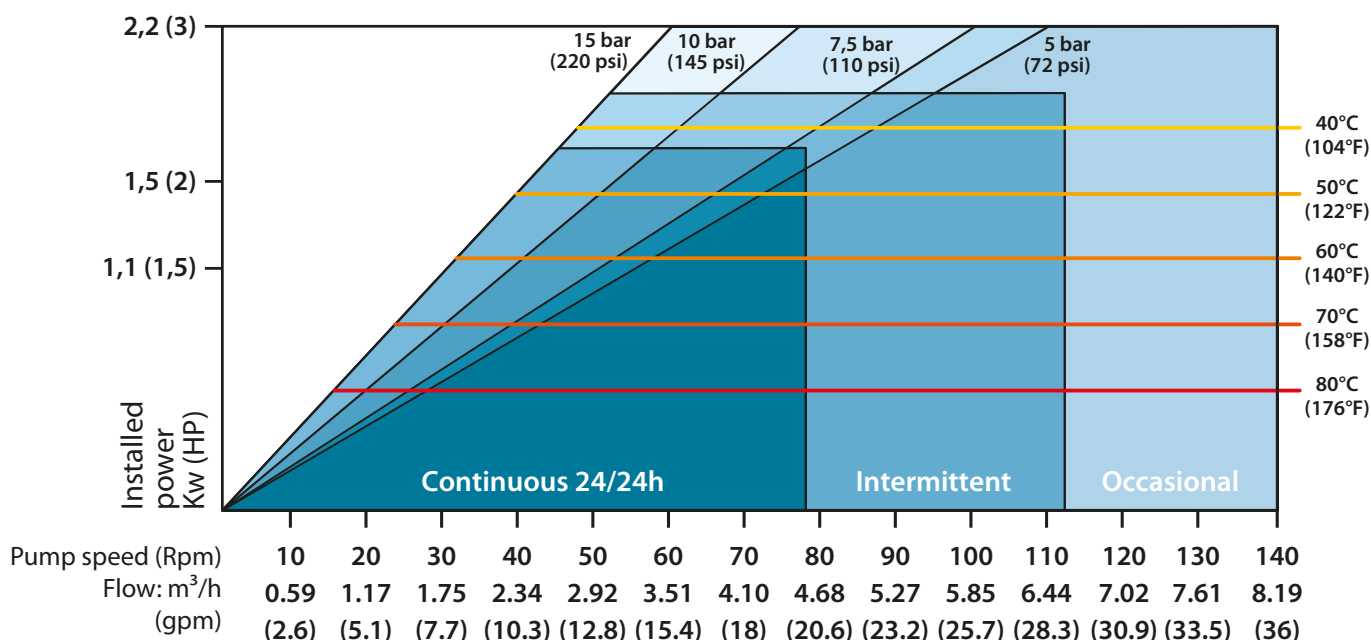

Excellence In Fluid Handling







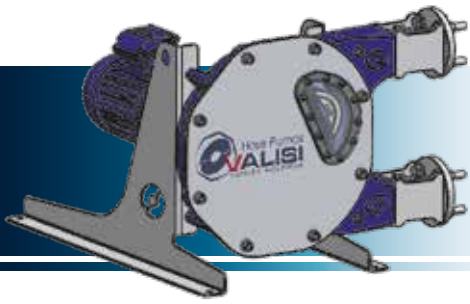

## Valisi Hose pumps a brand of Asco Pompe

Via Silvio Pellico, 6/8 - 20089 Rozzano (MI) - ITALY  
 Phone: +39 02 89257.1 - Fax: +39 02 89257.201  
[www.ascopompe.com](http://www.ascopompe.com) - [www.valisipumps.com](http://www.valisipumps.com)  
[asco@ascopompe.com](mailto:asco@ascopompe.com) - [info@valisipumps.com](mailto:info@valisipumps.com)  
[hosepumps@valisipumps.com](mailto:hosepumps@valisipumps.com)



### Hose construction

-  NR (black hose, white stripe)
-  NBR - Nitrile (black hose, yellow stripe)
-  EPDM (black hose, red stripe)
-  Hypalon - CSM (black hose, blue stripe)
-  FKM - Viton® (black hose, purple stripe)
-  NR FDA - Natural rubber FDA (black hose with internal white layer, double white stripe)
-  NBR FDA - Nitrile FDA (black hose, white/yellow stripe)

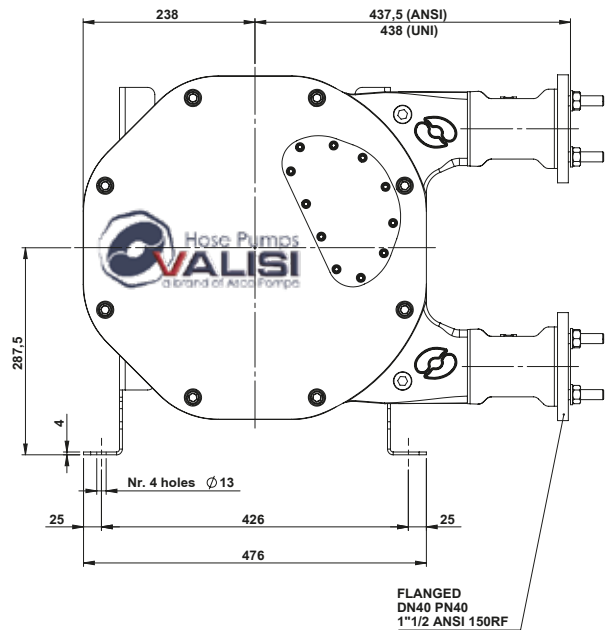
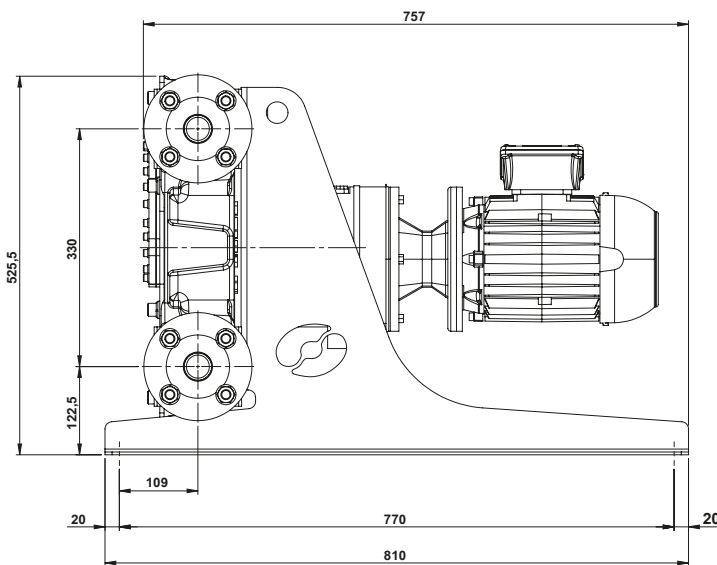

### Weight

Bare pump:	88 kg
Complete unit:	145Kg



### Valisi Hose pumps a brand of Asco Pompe

Via Silvio Pellico, 6/8 - 20089 Rozzano (MI) - ITALY  
 Phone: +39 02 89257.1 - Fax: +39 02 89257.201  
[www.ascopompe.com](http://www.ascopompe.com) - [www.valisipumps.com](http://www.valisipumps.com)  
[asco@ascopompe.com](mailto:asco@ascopompe.com) - [info@valisipumps.com](mailto:info@valisipumps.com)  
[hosepumps@valisipumps.com](mailto:hosepumps@valisipumps.com)