











### Hose construction

-  NR (black hose, white stripe)
-  NBR - Nitrile (black hose, yellow stripe)
-  EPDM (black hose, red stripe)
-  Hypalon - CSM (black hose, blue stripe)
-  FKM - Viton® (black hose, purple stripe)
-  NR FDA - Natural rubber FDA (black hose with internal white layer, double white stripe)
-  NBR FDA - Nitrile FDA (black hose, white/yellow stripe)

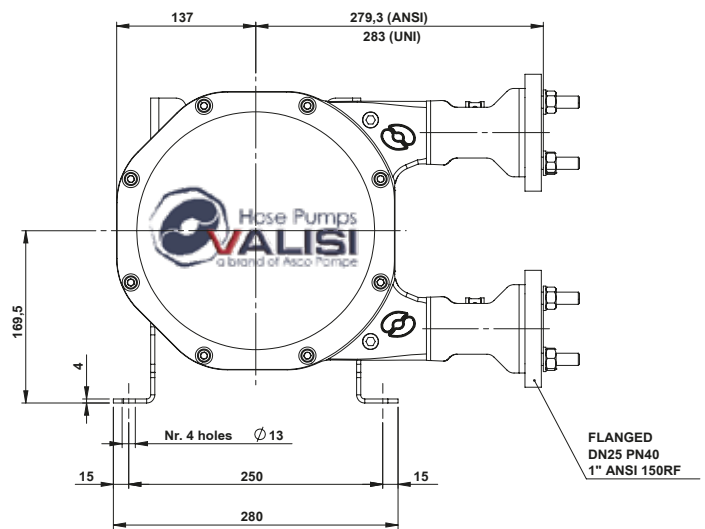
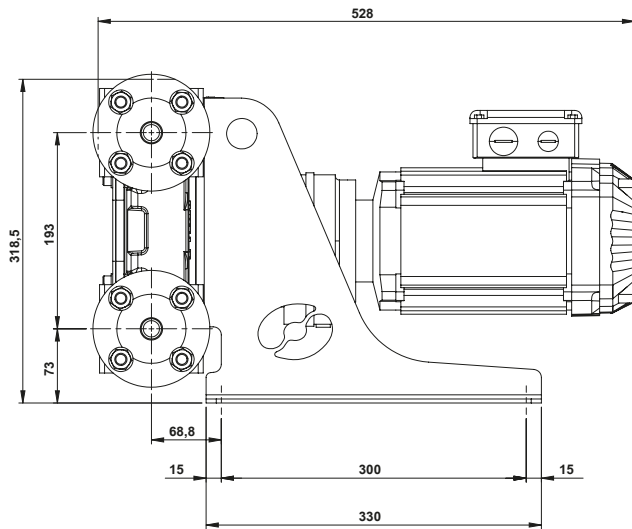

### Weight

Bare pump:	22 kg
Complete unit:	36 Kg



### Valisi Hose pumps a brand of Asco Pompe

Via Silvio Pellico, 6/8 - 20089 Rozzano (MI) - ITALY  
 Phone: +39 02 89257.1 - Fax: +39 02 89257.201  
 www.ascopompe.com - www.valisipumps.com  
 asco@ascopompe.com - info@valisipumps.com  
 hosepumps@valisipumps.com