

HOSE PUMP
Model VPH05-3
 SHOE TECHNOLOGY

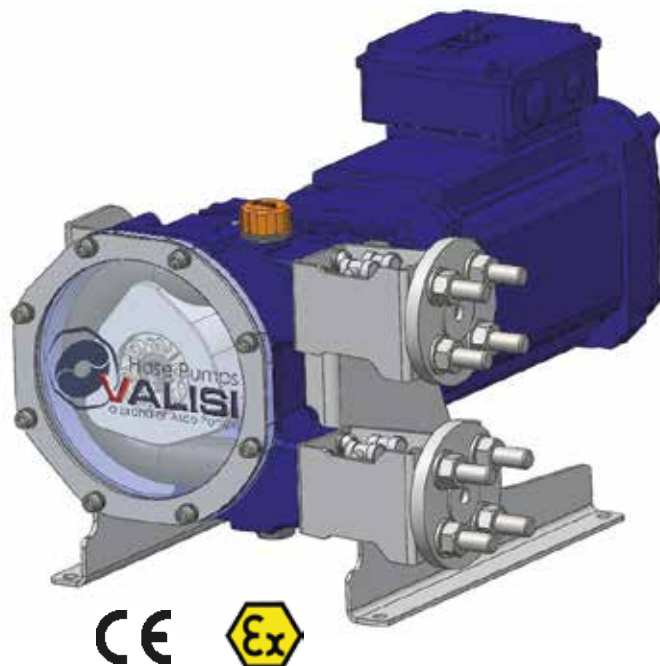

Specifications

| | |
|--------------------------|------------------------|
| Flow per revolution: | 0,0057 l |
| Max. discharge pressure: | 8 bar |
| Std. connections: | flanged DN15 (ANSI ½") |
| Internal hose diam.: | mm. 5 |
| Max liquid temp.: | 80°C (176°F) |
| Achievable suction: | up to 0,9 bar |
| Suitable for: | continuous operation |
| Feature: | Tri-lobe version |



VPH05-3 Performance

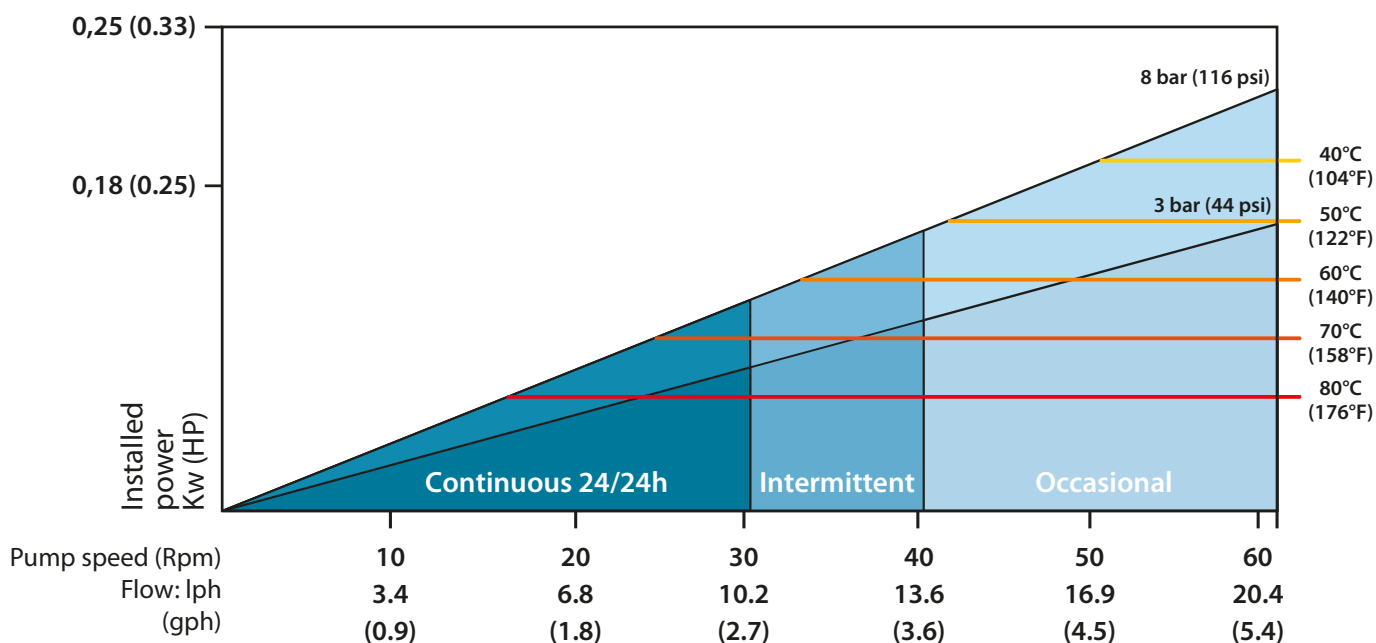



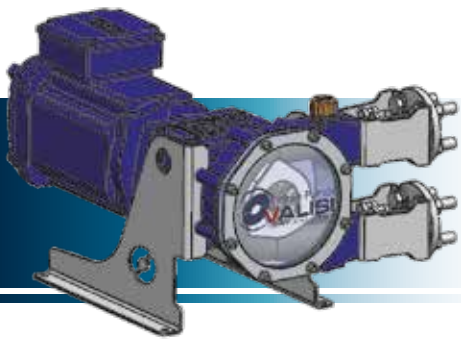

Valisi Hose pumps
 a brand of Asco Pompe

Via Silvio Pellico, 6/8 - 20089 Rozzano (MI) - ITALY
 Phone: +39 02 89257.1 - Fax: +39 02 89257.201
www.ascopompe.com - www.valisipumps.com
asco@ascopompe.com - info@valisipumps.com
hosepumps@valisipumps.com



Hose construction

-  NR (black hose, white stripe)
-  NBR - Nitrile (black hose, yellow stripe)
-  EPDM (black hose, red stripe)
-  NR FDA - Natural rubber FDA (black hose with internal white layer, double white stripe)

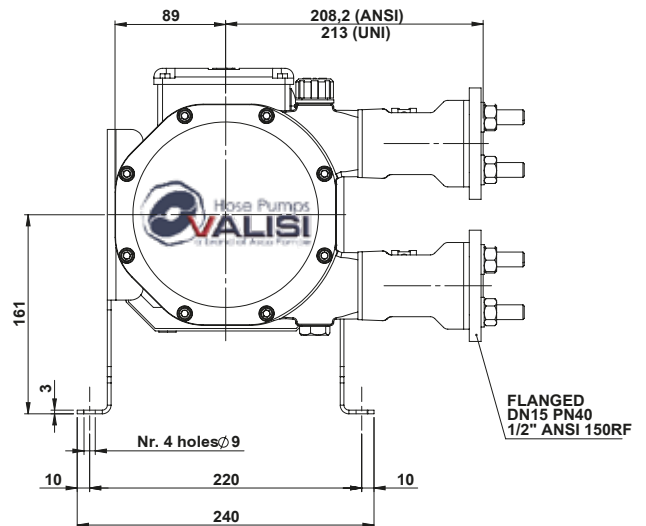
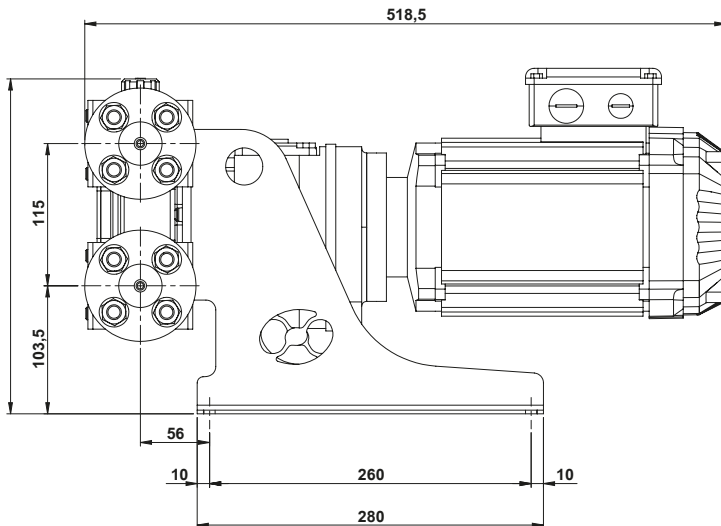

Weight

| | |
|----------------|-------|
| Bare pump: | 11 kg |
| Complete unit: | 25 Kg |



Valisi Hose pumps a brand of Asco Pompe

Via Silvio Pellico, 6/8 - 20089 Rozzano (MI) - ITALY
 Phone: +39 02 89257.1 - Fax: +39 02 89257.201
www.ascopompe.com - www.valisipumps.com
asco@ascopompe.com - info@valisipumps.com
hosepumps@valisipumps.com