

HOSE PUMP Model N7N

ROLLER TECHNOLOGY



Specifications

Max. Flow Rate:	10,4 m ³ /h (45,7 gpm)
Flow per revolution:	1,92 l
Max. discharge pressure:	7 bar
Std. connections:	flanged DN50 (2" ANSI)
Internal hose diam.:	mm.45
Max liquid temp.:	90°C (194°F)
Achievable suction:	up to 0,8 bar
Suitable for:	intermittent operation

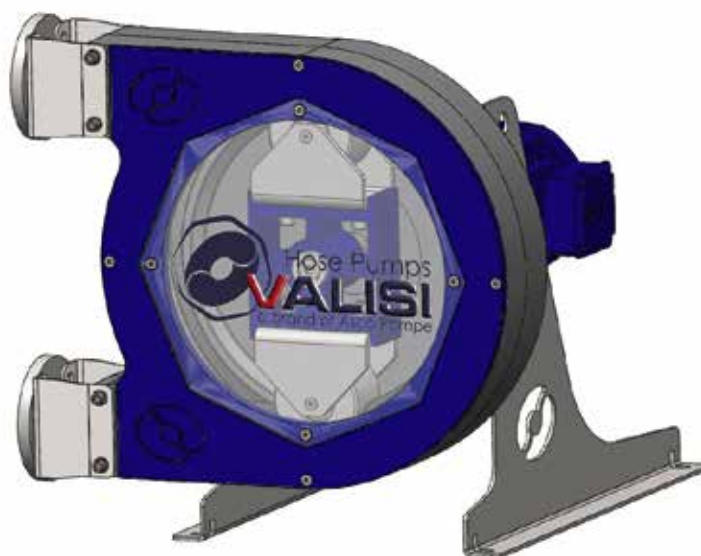

N7N Performance

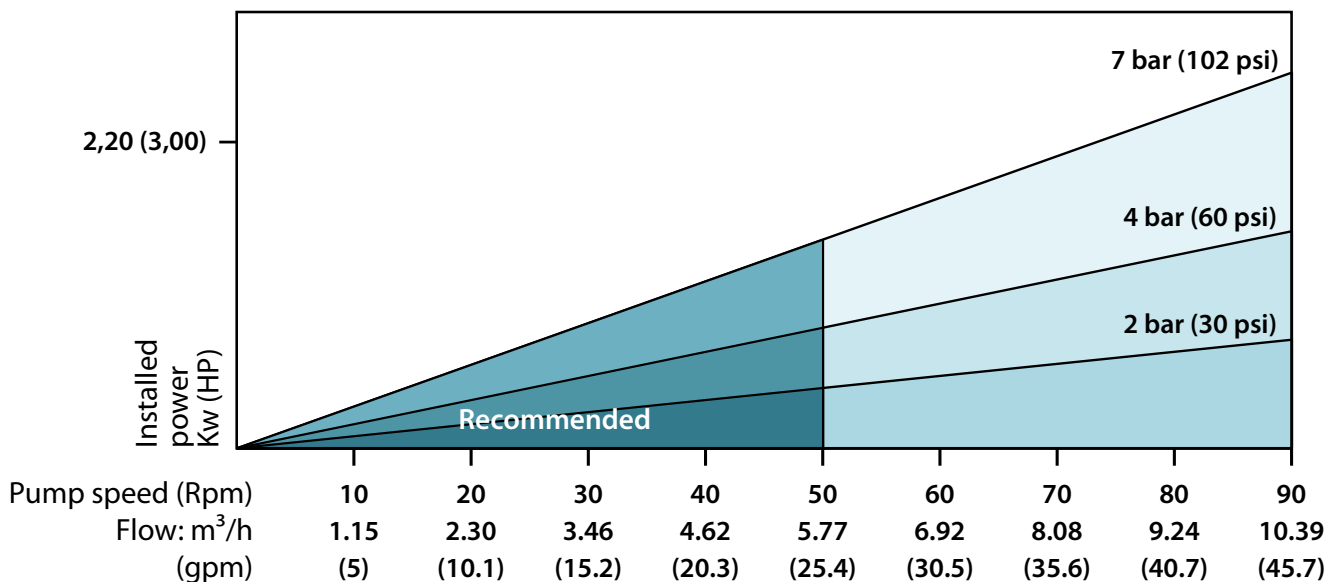

Excellence In Fluid Handling





Valisi Hose pumps
a brand of Asco Pompe

Via Silvio Pellico, 6/8 - 20089 Rozzano (MI) - ITALY
Phone: +39 02 89257.1 - Fax: +39 02 89257.201
www.ascopompe.com - www.valisipumps.com
asco@ascopompe.com











Hose construction

Not reinforced:

-  Tygon A60F (Varpren/Norprene A55F), FDA approved & NSF51 (cream white)
-  Silicon (Red)

Fiber braided (reinforced):

-  NR (green stripe)
-  NRF-K long life (black hose with Valisi logo)
-  NBR (red stripe)
-  EPDM (white stripe)
-  NR Food grade (white & green stripe and white interior)
-  FKM - Viton® (purple stripe)
-  NBR Food Grade (black hose with white interior)
-  Hypalon (yellow stripe)

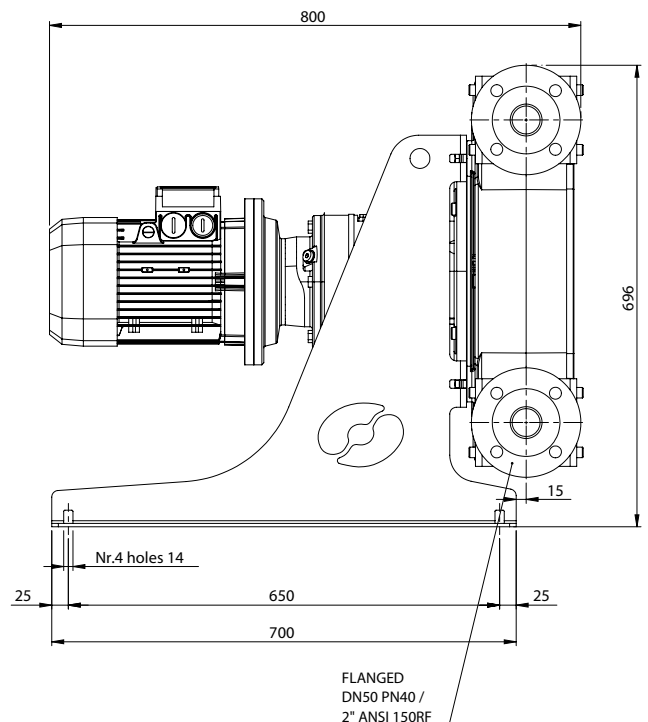
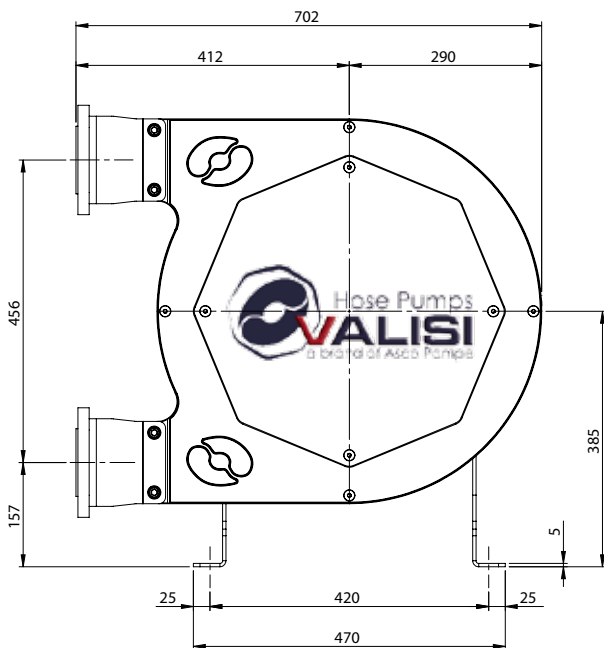

Weight

- N7NF (fixed speed): 178 kg
- N7NVM (mechanical variator): 190 Kg



Excellence In Fluid Handling



Valisi Hose pumps a brand of Asco Pompe

Via Silvio Pellico, 6/8 - 20089 Rozzano (MI) - ITALY
 Phone: +39 02 89257.1 - Fax: +39 02 89257.201
www.ascopompe.com - www.valisipumps.com
asco@ascopompe.com